

735

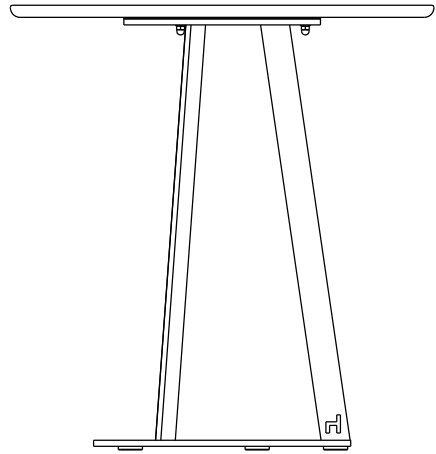

425

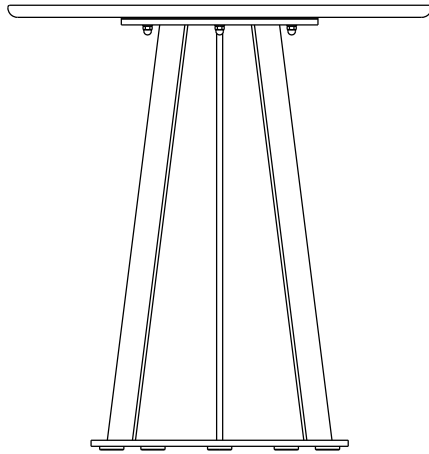
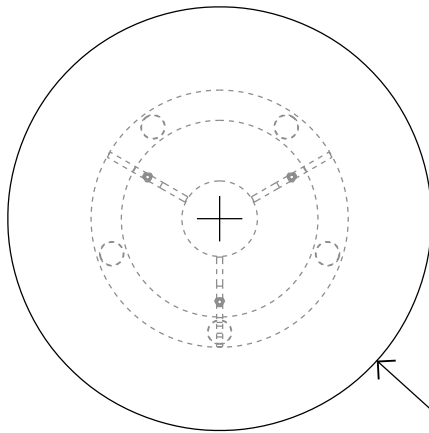

Ø700